

POWER REQ'TS
 240 VOLTS
 1 PHASE
 60 HERTZ
 90 AMPS
 21600 WATTS

WIRE SIZES
 NOTE: ALL WIRES TO BE
 TYPE SEW/SF2, #10 AWG
 MINIMUM UNLESS NOTED

#6095
 60A RELAY
 208-240V
 COIL
 DPST-NO

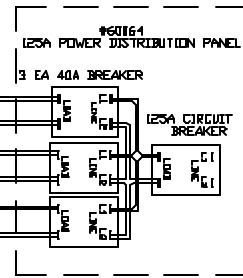
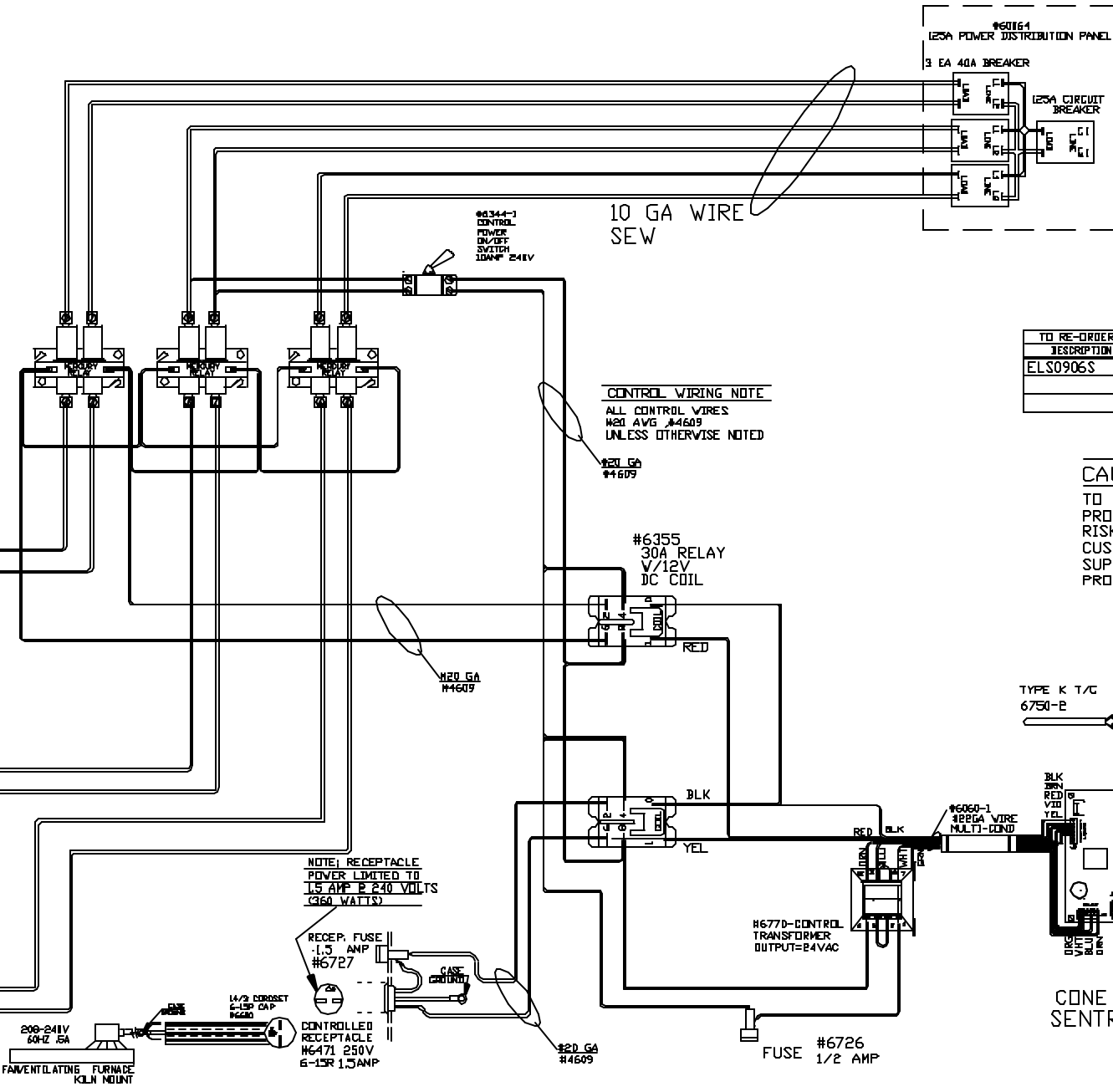
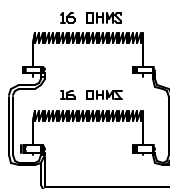
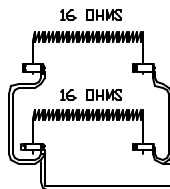
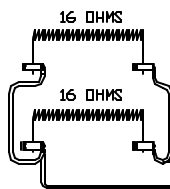

#6344-1
 CONTROL
 POWER
 ON/OFF
 SWITCH
 100AMP 241V

10 GA WIRE
 SEW

CONTROL WIRING NOTE
 ALL CONTROL WIRES
 #12 AWG #4609
 UNLESS OTHERWISE NOTED

#6355
 30A RELAY
 V/12V
 DC COIL

NOTE: RECEPTACLE
 POWER LIMITED TO
 15 AMP @ 240 VOLTS
 (360 WATTS)

RECEP. FUSE
 1.5 AMP
 #6727

CONTROLLED
 RECEPTACLE
 #6471 250V
 E-15R 1.5AMP

FUSE #6726
 1/2 AMP

#677D-CONTROL
 TRANSFORMER
 OUTPUT=24VAC

TO RE-ORDER ELEMENTS, SPECIFY		
DESCRIPTION	QTY	LOC
ELS0906S	6	SIDE

CAUTION
 TO PROVIDE CONTINUED
 PROTECTION AGAINST THE
 RISK OF ELECTRIC SHOCK,
 CUSTOMER'S POWER
 SUPPLY MUST BE
 PROPERLY GROUNDED.

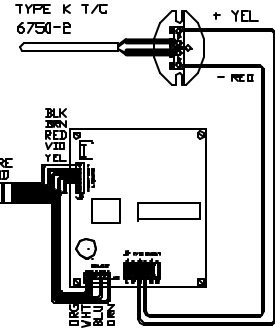

CONE FIRE
 SENTRY 2.0

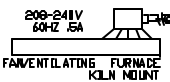

REV	DATE	BY	DESCRIPTION
-	9/14/04	DTB	

SWITCH BOX ASSY- 42077
 PARAGON INDUSTRIES
 2011 SOUTH TOWN EAST BLVD
 MESQUITE, TEXAS 75149

WIRING DIAGRAM
 240V, 1 PHASE ,60HZ 21600WATTS

PART NBR	REV
S0906	-
KL273627	

CFG 21
 2350°F