

# DUNCAN MODEL DA 1029-6L

## BODY PARTS

REF. NO.	PART NO.	DESCRIPTION
1.	KC 117	LID SUPPORT GUARD
2.	KC 018	1020/29 BRICK LID (BANDED & COATED) WITH VENT HOLE
3.	KC 049	COLLAR CASE W/CLAMPS
4.	KC 048	CASE W/CLAMPS
5.	KC 003	1020/29 BRICK BOTTOM
6.	KP 303	BASE PLATE
7.	KC 070	STAND W/FEET
8.	KE 030	STAND FEET
9.	KP 028	HEAT SHIELD
10.	KP 024	COLLAR HEAT SHIELD
11.	KC 035	CONTROLL PANEL SHELL
12.	KA 163	PILOT LIGHT
13.	KC 222	HINGE PIVOT KIT
14.	KM 302	PAL NUT
15.	KM 319	EA SWITCH KNOB
16.	KM 402	ASO
17.	KM 353	1020/29 POWER SUPPLY CORD
18.	KE 343	1020/29 CORD STRAIN RELIEF
19.	KE 302	#8 X 1" SHEET METAL SCREW
20.	KE 301	#8 X 1/2" SHEET METAL SCREW
21.	KA 030	PEEPHOLE PLUG
22.	KE 008	HANDLE
23.	KC 112	1020/29 LID SUPPORT
24.	KC 115	LID SUPPORT MOUNTING KIT
25.	KC 203	RIGHT HINGE W/PIVOT
26.	KC 213	LEFT HINGE W/PIVOT
27.	KB 003	GROOVED BRICK
28.	KB 013	TERMINAL BRICK
29.	KB 023	PEEPHOLE BRICK
30.	KB 043	HALF BRICK
31.	KB 053	KILN SITTER BRICK
32.	KE 098	2 POLE TERMINAL STRIP
33.	KM 324	POWER RELAY
34.	KM 323	2 IN 1 TIMER
35.	KE 307	#8-32 X 1 1/4" SCREW
36.	KC 138	14" CONNECTING WIRE, 12 GA.
37.	KC 139	5" CONNECTING WIRE, 12 GA.
38.	KE 329	#8-32 NUT W/LOCK WASHER
39.	KC 189	10" CONNECTING WIRE, 18 GA.
40.	KM 300	INFINITE SWITCH W/PAL NUT(220V 240V)
41.	KC 418	18.4. WIRE COMBO 18 GA.
42.	KC 173	6.4 WIRE COMBO 18 GA.
43.	KC 177	6" CONNECTING WIRE
44.	KM 383	4" FIBERGLASS SLEEVING
45.	KC 309	STANDARD BUSS BAR ASSEMBLY
46.	KC 319	U-TERMINAL ASSEMBLY
47.	KE 080	INSULATOR
48.	KC 381	3 POSITION SWITCH
49.	KM 382	CAPACITOR ASSEMBLY #2
50.	KE 220	ELEMENTS (220V)
51.	KE 303	#6 X 1/2" SHEET METAL SCREW
52.	KE 311	#10-32 X 1/2" SHEET METAL SCREW
53.	KC 179	18" WIRE 12 GA.
54.	KE 314	#6-32 X 1/2" MACHINE SCREW
55.	KE 321	#10 STAR WASHER
56.	KE 322	#8 STAR WASHER
57.	KC 184	22.4 WIRE COMBO 18 GA.
58.	KC 182	5" CONNECTING WIRE 12 GA.
59.	KE 332	#10 HEX NUT
60.	KE 333	#6 HEX NUT
61.	KE 341	1/8" STAND OFF
62.	KC 180	20" CONNECTING WIRE 12 GA.
63.	KC 419	15" CONNECTING WIRE 18 GA.

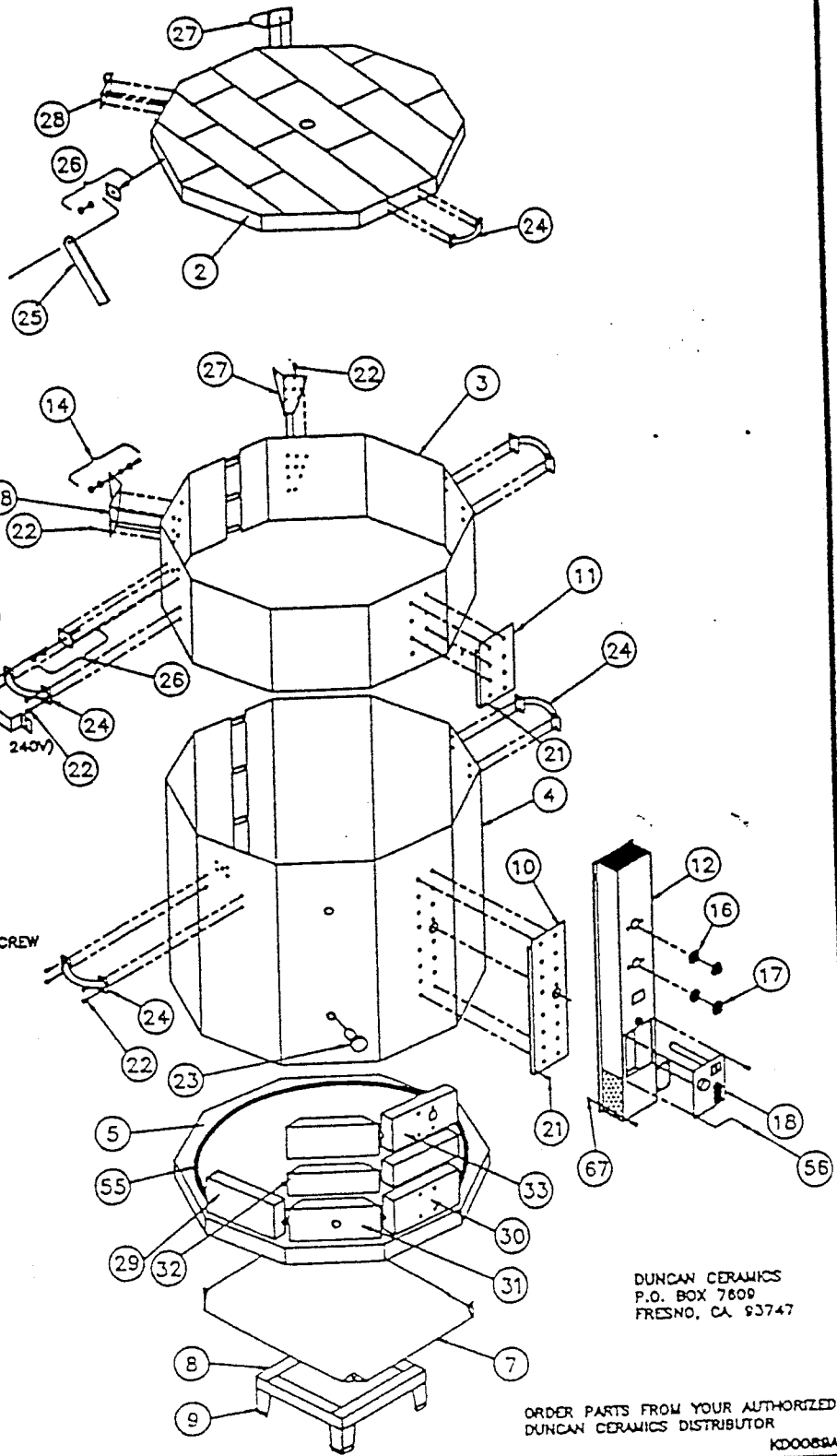

DUNCAN CERAMICS  
P.O. BOX 7809  
FRESNO, CA 93747

ORDER PARTS FROM YOUR AUTHORIZED  
DUNCAN CERAMICS DISTRIBUTOR

KD0089A