

PARAGON KILN MODEL A-11-6B WIRING DIAGRAM AND PARTS IDENTIFICATION

The letter "B" following the Model Number means the kiln has a stainless steel jacket.

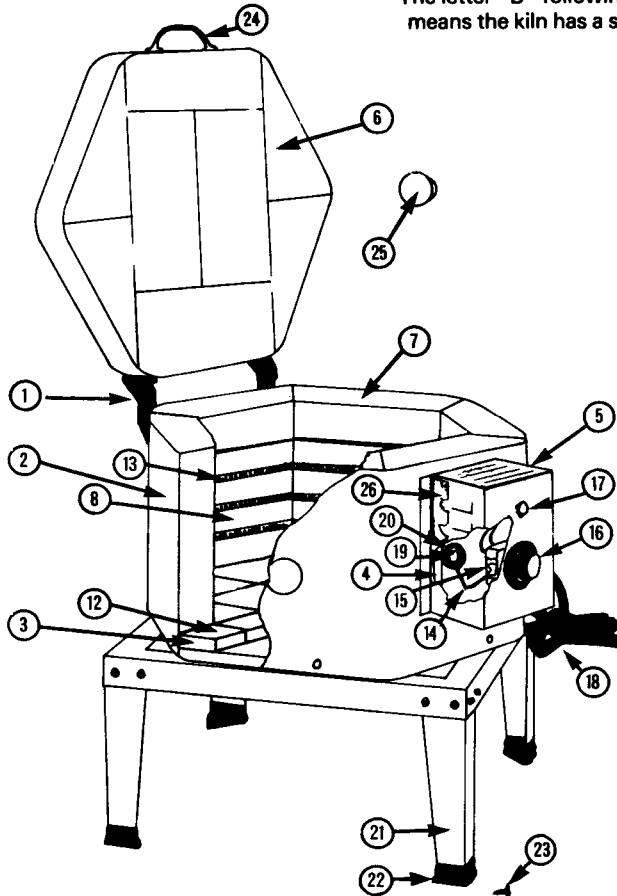

PARAGON KILN MODEL A-11-6B

REF. NO.	PART NO.	DESCRIPTION
METAL JACKET PARTS		
1.	Specify Model	Hinge, complete, gray
2.	Specify Model	Form-Fitted Jacket, stainless
3.	Specify Model	Full-Formed Steel Base
4.	Specify Model	Heat Shield
5.	Specify Model	Ventilated Switch Box, metal only, gray
INSULATING FIREBRICK		
6.	BR-11-6	Brick Lid with Band, stainless (less hardware)
7.	BR-6-11-6	2" Plain Wall Brick
8.	BR-2-11-6	4" Straight Grooved Wall Brick
9.	BR-4-11-6	4" Peephole Wall Brick (not shown)
10.	BR-3-11-6	4" Terminal Wall Brick (not shown)
11.	BR-5-11-6	4" Kiln-Sitter Wall Brick (not shown)
12.	BR-10-11-6	Brick Bottom, only
ELECTRICAL PARTS		
13.	EL.A-11-6	Heating Element for A-11-6B
14.	WR-4	#14 Switch-to-Element Lead Wires, push-on terminal one end
15.	SW-5	Switch, 120 v., Stepless Control for push-on terminals
16.	KN-4	Knob for Stepless Control
17.	MS-7	Pilot Light with Lead Wires, complete
18.	CR-4	14-3, 120 v., 6 ft. cord with plug
19.	MS-6	Element Connectors
20.	MS-1	Porcelain Insulators (1 1/8" long)
OTHER REPLACEMENT PARTS		
21.	ST-4	Kiln Stand, 12" square for 6-sided A-series
22.	ST-1	Plastic Feet, only, for kiln stand
23.	HW-8	#8 Plated Metal Screws
24.	HW-4	Lid Handle for small A-series (8-sided or less)
25.	PL-2	Peephole Plug, Cone Shaped for A-series
26.	HW-7	Fall Away, Prop-R-Vent Kit

For prices of parts, see your current Paragon Kiln Catalog Price List. All prices are F.O.B. factory, Dallas County, Texas and are subject to change without notice.

WHEN ORDERING PARTS, ALWAYS SPECIFY MODEL NUMBER, REFERENCE NUMBER, PART NUMBER AND DESCRIPTION

MERCHANDISE TO BE SHIPPED TO ONE ADDRESS ON ONE ORDER MUST TOTAL \$5.00 BEFORE THE POSTAGE AND HANDLING CHARGES ARE ADDED.

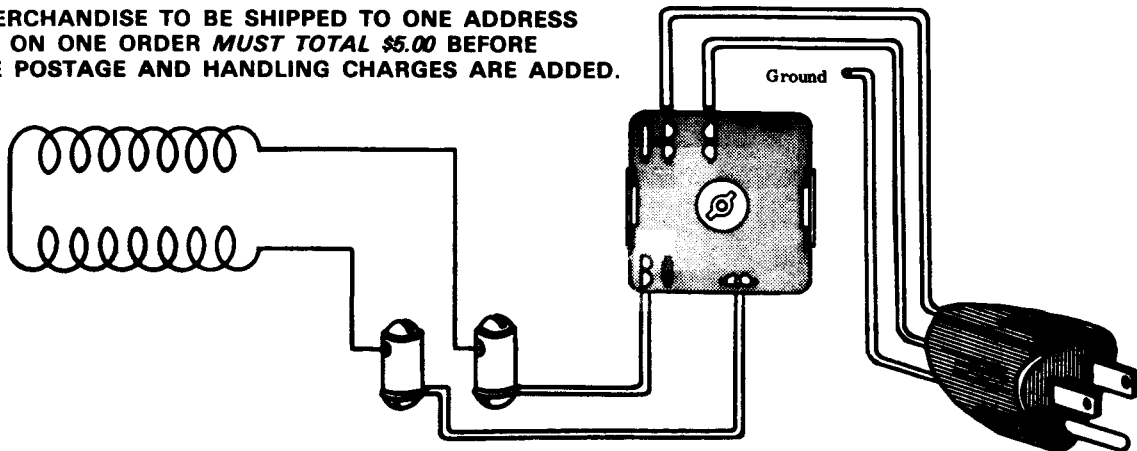

Paragon INDUSTRIES

2011 South Town East Blvd.
Mesquite, Texas 75149-1122
214/288-7557

© Copyright Paragon Industries, Inc. 1977

IM-12/1277