

# How to Replace a Switch on a Paragon Kiln

Replacing a switch on a Paragon kiln is simple yet different from replacing a switch on other appliances, so please read these instructions. A mistake could ruin your new switch.

1. Remove switch knob. Some switch knobs are removed by pulling straight out. Others are removed by loosening a set screw on the side of the knob. So check to see if a set screw is securing the knob to the switch before pulling on it.



2. Always **UNPLUG** kiln before removing switch box. Remove and save the screws on the side of the switch box that hold it to the kiln and let the switch box hang by the switch-to-element lead wires. (If your kiln is equipped with a separate control panel, remove the front of the control panel.)

3. Hold the new switch next to the old one, which is still mounted on the switch box. The new switch should face the same direction as the old one.



## Push-on Terminals

Remove and transfer one wire at a time from the old switch to the new one making sure the connection is tight when it is pushed on. If a push-on terminal does not have a snug fit, gently squeeze the end of the terminal with pliers. A tight connection is important!

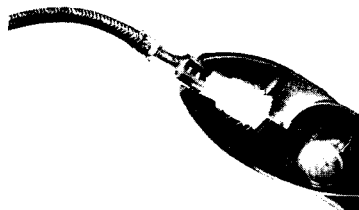

## Screw-On Terminals

Remove only one screw at a time from the old switch and transfer the wires under that screw to the same terminal on the new switch. Polish each eyelet to a bright brassy color with sandpaper before moving it to the new switch. Tighten the screw on the new switch securely before removing the next screw on the old switch. When all wires have been transferred to the new switch, go over the screws again to be sure they're tight.



4. Remove the nut from the front of the switch (previously under the knob). Then remove the defective switch and put the new one in its place. Install the new switch in the same position as the old one, because the indicator marks on the knob cannot be read correctly if the switch is turned from its original position. After the switch is in place, put the shaft nut on, checking to make sure it isn't backwards, and securely tighten so the switch will not turn during operation.

**IMPORTANT:** As you move the switch box back into place, check to see that no wires are touching each other or the element connectors. Wires or wire nuts also must not touch the kiln case. *Wires and wire nuts will burn if they touch the case or element connectors.*

5. Fasten the switch box to the kiln using the screws removed in Step 2.
6. Line up the flat side of the switch shaft with the flat side of the switch knob hole and push knob back in place. If your switch knob is held in place with a set screw, line up the set screw with the flat side of the switch shaft and tighten set screw. Turn the knob to make sure it's working.

## Replacing the Old Style 4-Way Rotary Switch with New Style (Converting from Screw-On Terminal To Push-On Terminal)

The old style 4-way rotary switch has screw-on connections. The new style has push-on connections. Regrettably we can no longer buy the old style switch, so to replace one, the eyelet terminals on the wires must be replaced with push-on terminals. This is fairly easy if you know how to attach a terminal to a wire with a crimping tool. You'll need a package of TR-5 large and small push-on terminals and a crimping tool. Read "How to Replace a Switch" in addition to this section. You may need to order extra wire from us, because after the eyelet terminals are cut off and replaced with push-on terminals, the wires will be slightly shorter.

When only one wire is connected to a screw terminal on the old switch, use a push-on terminal to attach that wire to the new switch. Use the conversion chart on this sheet to know where the same terminal is on the new switch.

When two or more wires are under a screw terminal, crimp them to the same push-on terminal. If the large push-on terminal is too small to hold all the wires, use a wire nut (MS-4 small or MS-5 large) to attach the wires to a #12 jumper wire. Then connect the jumper wire to the switch with a push-on terminal. Use only our wire, terminals and wire nuts. Most of the parts sold in hardware stores are not made for high temperatures.

When you crimp a terminal to a wire, test the crimp by yanking on the terminal. *The terminal must be tight!* A loose terminal can ruin your new switch by arcing and overheating.

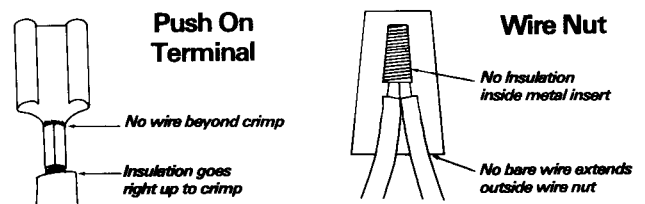

(Continued on back)

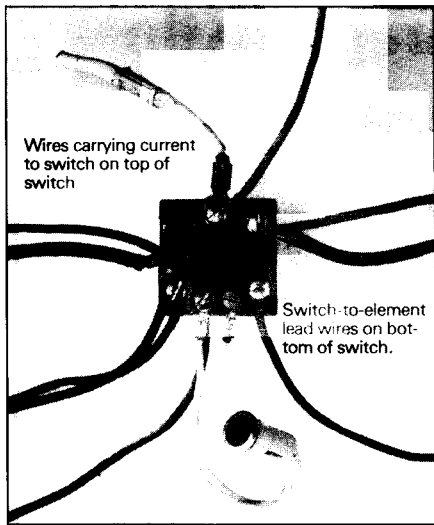

**Old style 4-way rotary switch.**

This is what your switch will look like before you convert to the new style switch. The center picture shows you how to attach push-on terminals to the wires.

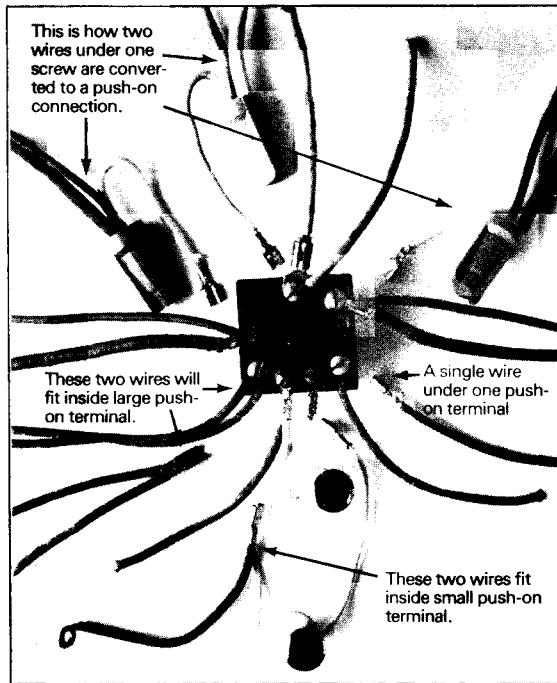

**How the conversion is made.**

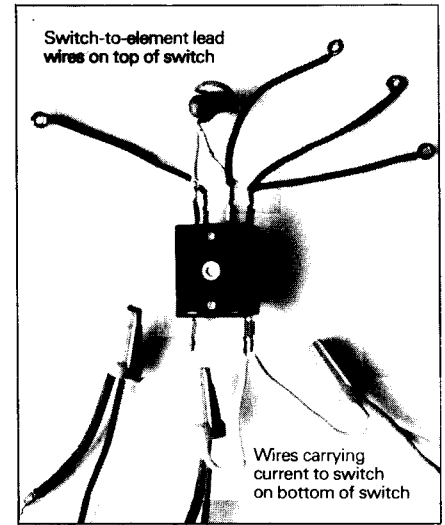

**New style 4-way rotary switch.**

The wires that were held in place with screw-on terminals on the old switch are now attached to the new switch with push-on terminals.

# Switch Equivalent Charts

## Changing Old Style 4-way Rotary To New Style 4-way Rotary

Old and new style 4-way rotary switches are interchangeable. If you are replacing an old style 4-way rotary switch, the charts below will show you where the wires go on the new switch. **IMPORTANT:** You should transfer only one wire at a time.

### 4-Way Rotary TAAP or TAAO Switch (Screw-on connections)

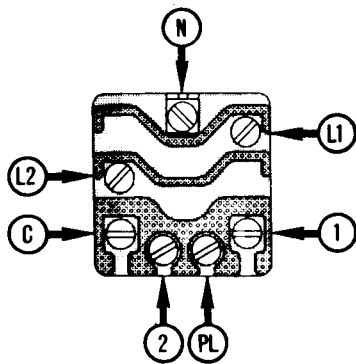

### 4-Way Rotary A-21 Switch (Push-on connections)

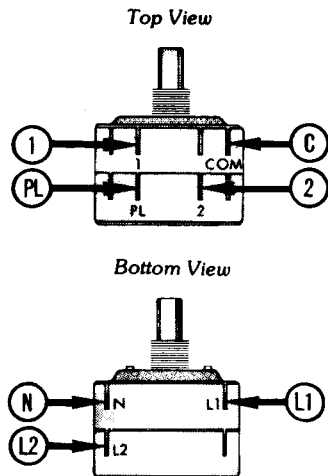

## Changing 3-way Rotary Switch To 4-way Rotary Switch

The 3-way rotary switch is no longer available. However, you can replace it with a 4-way rotary switch. As you remove a wire from the 3-way switch, find that connection on the 3-way switch chart below. Then follow the line to trace that wire to the 4-way switch. That is where the wire goes on the 4-way switch. Example: the wire on #1 of the 3-way switch transfers to #L1 on the 4-way switch. Transfer one wire at a time.

**SPECIAL NOTES:**

The pilot light wires, connected to #N and #L1 on the 3-way switch, transfer to #PL and #2 on the 4-way switch.

Some kilns have a wire on #3 of the 3-way switch. This connection is not necessary on the 4-way switch. If the wire on #3 doesn't go anywhere, discard it. If it is spliced in from a wire going to and from somewhere else, replace it with an unspliced wire.

### 3-Way Rotary Switch (Screw-on connections)      4-Way Rotary A-21 Switch (Push-on connections)

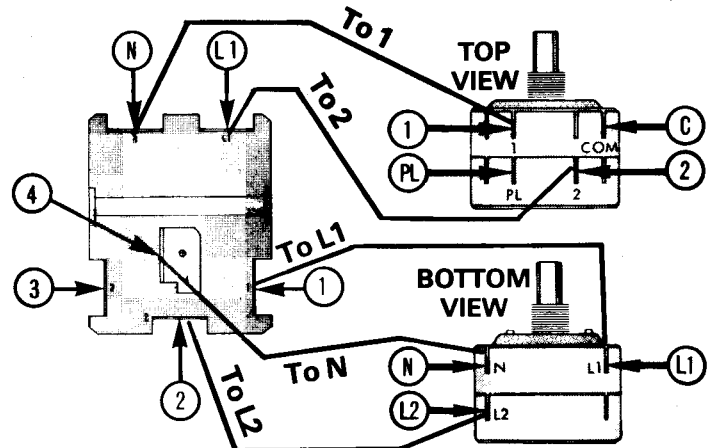

**Paragon Industries**  
 2011 South Town East Blvd.  
 Mesquite, Texas 75149  
 214/288-7557

*Firing into the future*