

DUNCAN MODEL DA 1020-6L,-6Z

BODY PARTS

REF. PART
NO. NO. DESCRIPTION

1. KM 326 4000 Repeat Cycle Timer (240/208V)
2. KM 325 4300 Fixed Interval Timer (240/208V)
3. KM 324 Power Relay (240/208V)
4. KE 314 #6-32 X 1/2" Machine Screw
5. KE 322 #8 Star Washer
6. KE 333 #6-32 Hex Nut
7. KM 343 4" Fiberglass Sleeving
8. KM 342 820, Cord Strain Relief
9. KE 307 #8-32 x 1-1/4" Machine Screw
10. KE 329 #8-32 hex Nut w/Washer
11. KE 098 2 Pole Terminal Strip
12. KC 309 Standard Buss Bar Assembly
13. KC 318 U-Terminal Assembly
14. KE 332 #10-32 Hex Nut
15. KE 000 Insulator
16. KE 321 #10 Star Washer
17. KM 067 Timer Motor (60 HZ)
18. KE 317 #10-32 x 3/8" Machine Screw
19. KM 330 1020/29 Power Supply Cord
20. KM 300 Infinite Switch w/Pal Nut (240/220V)
- OR
21. KM 301 Infinite Switch w/Pal Nut (208)
22. KC 189 10' Connecting Wire, 18 Gauge
23. KC 187 8' Connecting Wire, 18 Gauge
24. KC 171 10,8,6 Wire Combo, 18 Gauge
25. KC 177 6' Connecting Wire, 12 Gauge
26. KC 178 18' Connecting Wire, 12 Gauge
27. KC 163 EA Pilot Light
28. KC 136 8' Connecting Wire, 12 Gauge
29. KC 361 3 Position Switch
30. KC 173 6, 4 Wire Combo, 10 Gauge

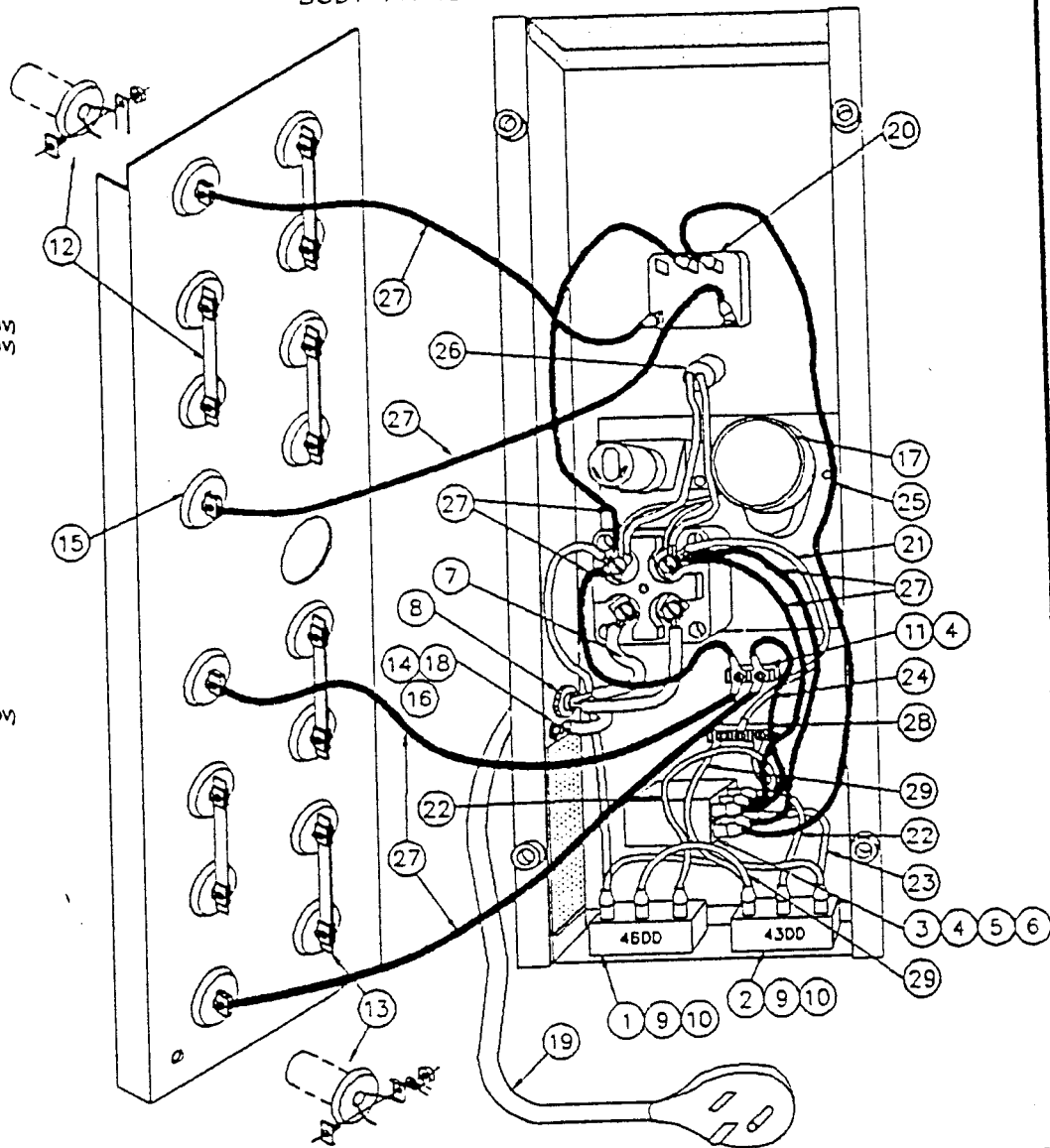

ELECTRICAL SCHEMATIC

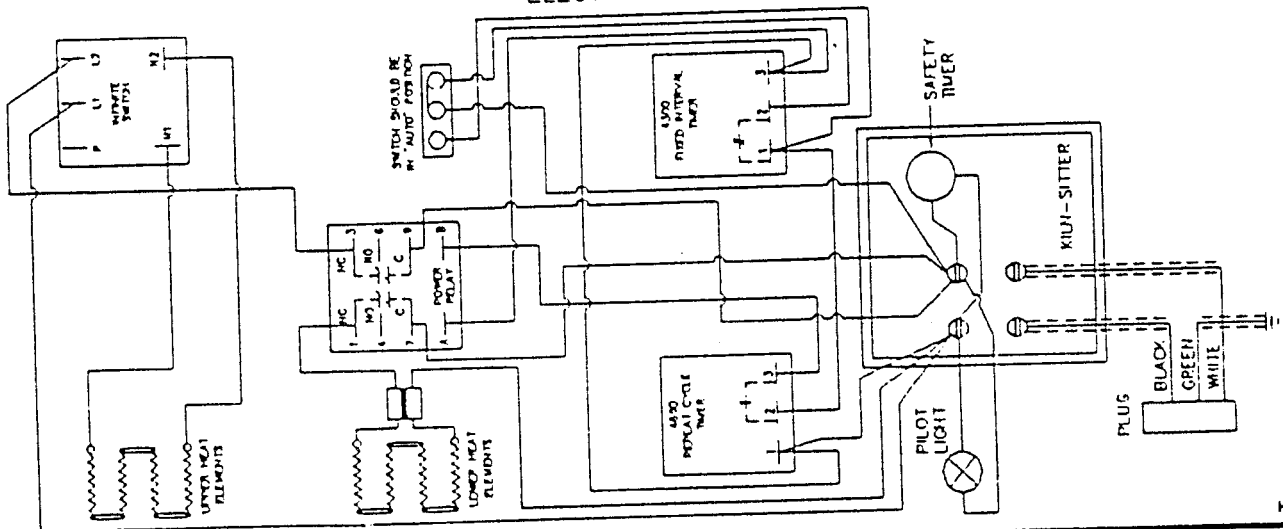

208/240 VAC
60 HZ

KD0071