

DUNCAN MODELS DE 1029-2,-4

BODY PARTS

REF. PART
NO. NO.

DESCRIPTION

1.	KC 117	LID SUPPORT GUARD
2.	KC 018	1020/29 BRICK LID (BANDED & COATED) WITH VENT HOLE
3.	KC 049	COLLAR CASE W/CLAMPS
4.	KC 048	CASE W/CLAMPS
5.	KC 003	1020/29 BRICK BOTTOM
7.	KP 303	BASE PLATE
8.	KC 070	STAND W/FEET
9.	KE 030	STAND FEET
10.	KP 028	HEAT SHIELD
11.	KP 024	COLLAR HEAT SHIELD
12.	KC 491	DE CONTROL PANEL SHELL 1029
13.	KE 353	THERMOCOUPLE ASSEMBLY
14.	KC 222	HINGE PIVOT KIT
15.	KC 495	DE CONTROL BOX SHELL
16.	KC 494	DE ELECTRONIC CONTROLLER
17.	KE 354	DE THERMOCOUPLE
18.	KC 480	4,4,18 WIRE COMBO 18GA
19.	KM 333	1020/29 POWER SUPPLY CORD
20.	KE 343	1020/29 CORD STRAIN RELIEF
21.	KE 302	#8 X 1" SHEET METAL SCREW
22.	KE 301	#8 X 1/2" SHEET METAL SCREW
23.	KA 030	PEEPHOLE PLUG
24.	KE 009	HANDLE
25.	KC 112	1020/29 LID SUPPORT
26.	KC 115	LID SUPPORT MOUNTING KIT
27.	KC 203	RIGHT HINGE W/PIVOT
28.	KC 213	LEFT HINGE W/PIVOT
29.	KB 003	GROOVED BRICK
30.	KB 013	TERMINAL BRICK
31.	KB 023	PEEPHOLE BRICK
32.	KB 043	HALF BRICK
33.	KB 089	DE THERMOCOUPLE BRICK
34.	KE 358	DE THERMOCOUPLE WIRE 10"
35.	KC 481	DE 4,4,18 WIRE COMBO 18GA
36.	KC 490	DE 25" CONNECTING WIRE
37.	KC 489	14" CONNECTING WIRE 12GA
38.	KE 307	#8-32 X 1 1/4" SCREW
39.	KC 500	DE 19" CONNECTING WIRE 12GA
40.	KC 501	DE 12" CONNECTING WIRE 12GA
41.	KC 502	DE 9" CONNECTING WIRE 12GA
42.	KC 482	DE 4" JUMPER WIRE 18GA
43.	KC 483	DE 4" CONNECTING WIRE-TRANSFORMER 18GA
44.	KC 486	DE 18" CONNECTING WIRE 18GA
45.	KE 359	DE THERMOCOUPLE WIRE 25"
46.	KC 503	DE 240V-24VAC TRANSFORMER
47.	KC 504	DE 240V 24V RELAY
48.	KM 383	4" FIBERGLASS SLEEVING
49.	KC 309	STANDARD BUSS BAR ASSEMBLY
50.	KC 319	U-TERMINAL ASSEMBLY
51.	KE 080	INSULATOR
52.	KE 223	DE 1029 ELEMENTS (240V)
OR	KE 233	DE 1029 ELEMENTS (208V)
53.	KE 341	1/8" STAND OFF
54.	KC 506	DE QUICK DISCONNECT-MALE
55.	KC 505	DE 6" CONNECTING WIRE 12GA
56.	KC 508	DE 1029 QUICK DISCONNECT-FEMALE
57.	KC 497	DE 1029 COMPLETE CONTROL PANEL
58.	KC 496	DE CONTROLLER ASSEMBLY W/BOX
59.	KE 355	DE THERMOCOUPLE WIRE 10"
60.	KE 356	DE THERMOCOUPLE WIRE 13"

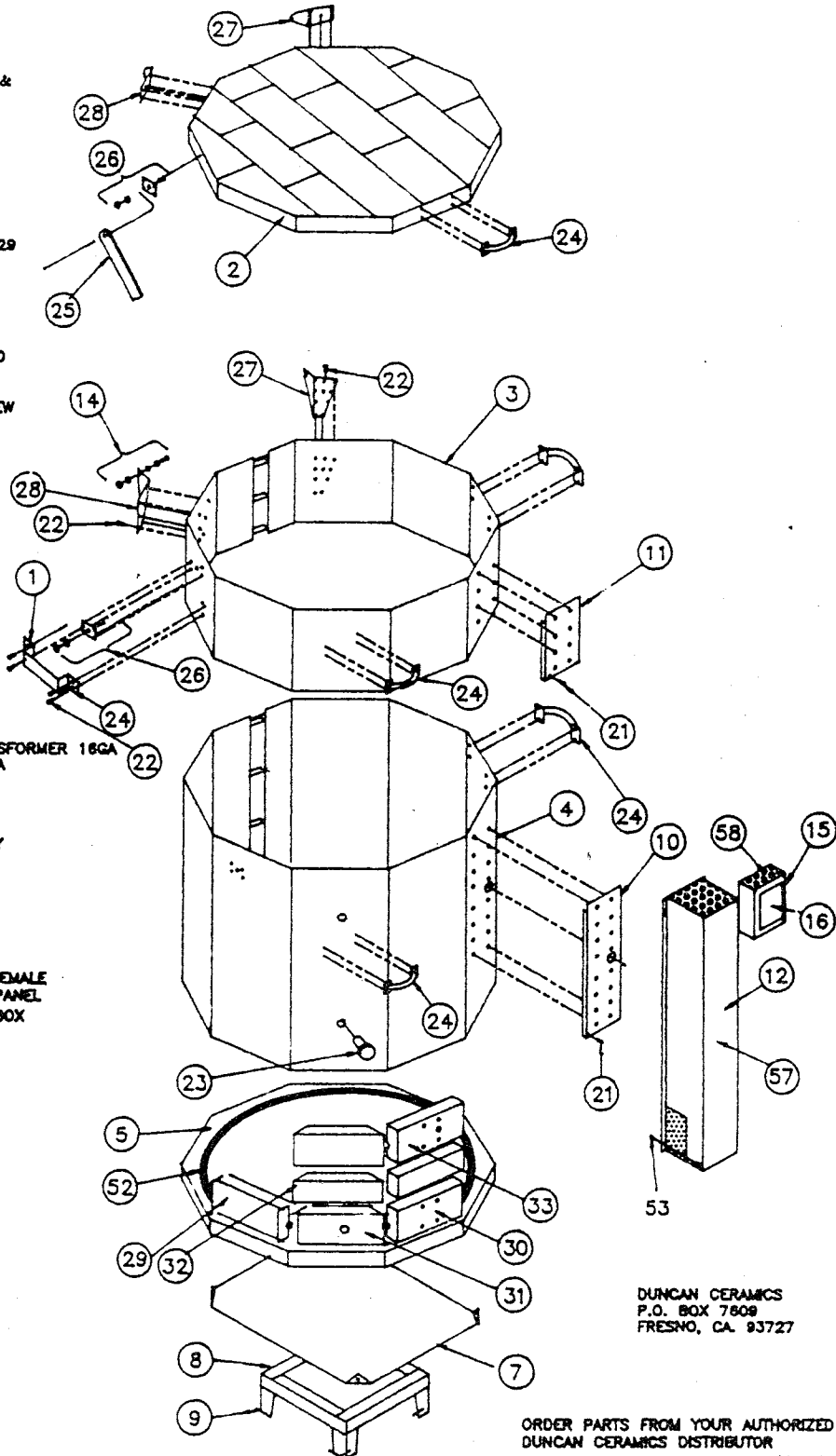

DUNCAN CERAMICS
P.O. BOX 7809
FRESNO, CA. 93727

ORDER PARTS FROM YOUR AUTHORIZED
DUNCAN CERAMICS DISTRIBUTOR

LX996